



Original Instructions

Warning! Read instructions before using machine



Operating Instructions

CVC 370

WV 370

WVT 370

WV 380

WV 470

Contents / Kits - AA12

2



Kit A21A

CVC 370



Kit AA12

WV 370
WV 380
WV 470



WVT 370

CVC 370 - WV 370
WV 380 - WVT 370



604016
NVM 2BH

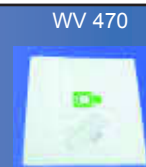

WV 470

604018
NVM 3AH



Wet - Assembling the machine

Wet - Using the machine

4

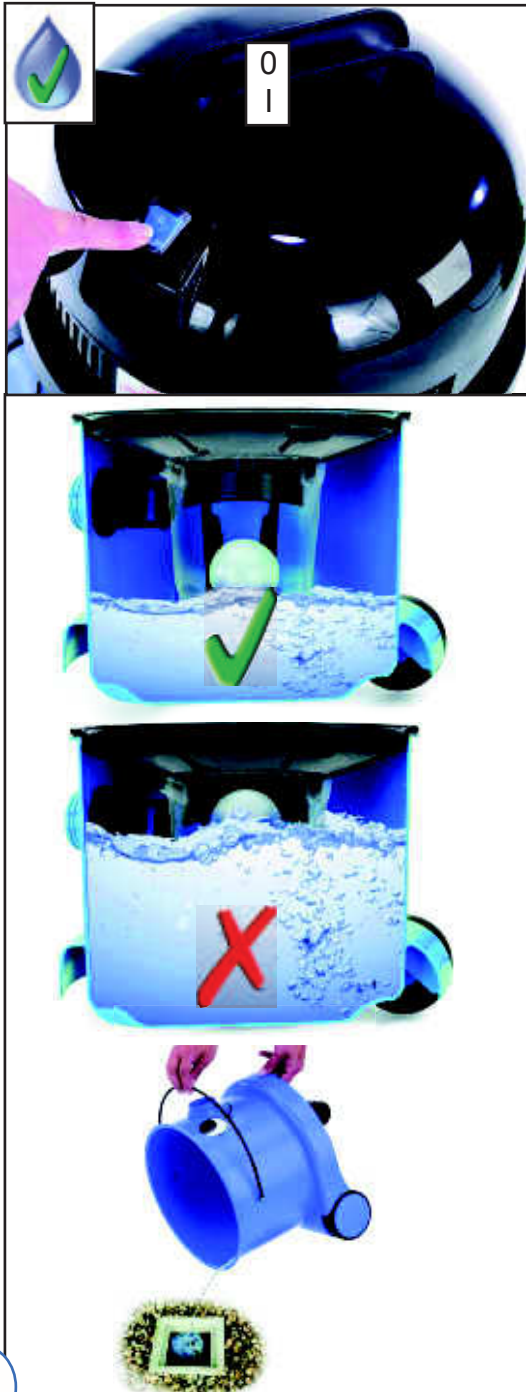



Dry-Assembling the machine

5

Assembling the Machine

6

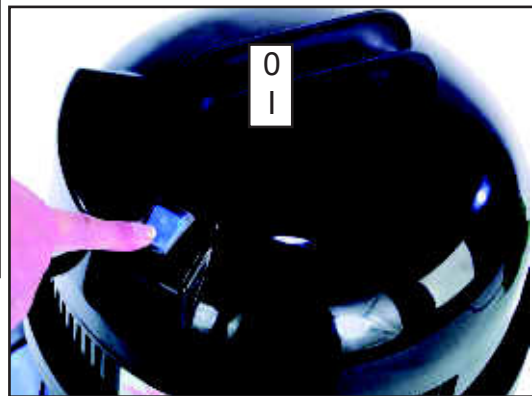
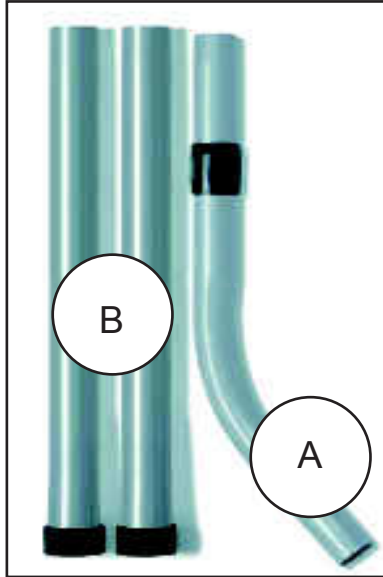

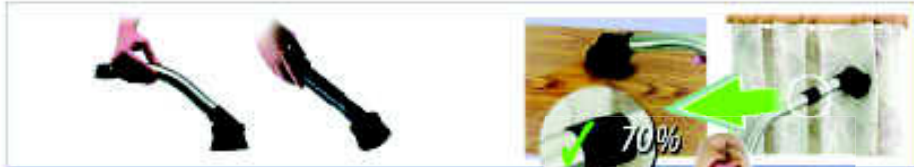
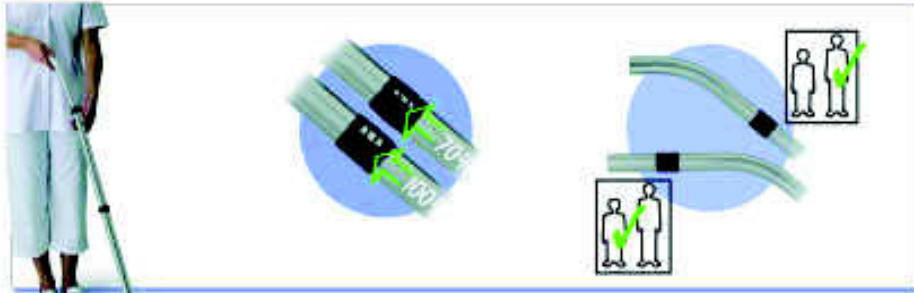

7

Using the machine

470 Handle Locking Instructions

8



About the machine

Company name and address

Weight (Ready to use) — 7.1 Kg

Voltage / Frequency — 230V~, 50-60 Hz

Power Rating — 1200W, 1000W

Splash Proof Rating — IPX4

Machine Description — CVC 370

WEEE Logo

Class 2 Symbol

CE Mark

Yr / Wk / Serial Number

**WEEE Legislation
(Waste, Electrical and Electronic Equipment)**

Vacuum cleaner, accessories and packaging should be sorted for environmental-friendly recycling.

Only for EU countries:
Do not dispose of Vacuum cleaner into household waste!
According to the European Directive 2002/96/EC on waste electrical and electronic equipment and its incorporation into national law.

Vacuum cleaners that are no longer suitable for use must be separately collected and sent for recovery in an environmental-friendly manner.

Safety Critical Components

Mains lead HO5VV-F x 10m x 2 x 1.00mm²

Filter Bag
(370 - 380 drum) NVM-2 BH >pp< construction 99.6%@0.3µm
(470 Drum) NVM-3 AH >pp< construction 99.6%@0.3µm

Filter

Tritex NVM 604165 >pp< construction 96.0%@0.3µm

Microtex NVM 604311 >pp< construction 99.6%@0.3µm

Microfresh NVM 604170 >pp< construction 98.4%@0.3µm

PPE

Personal protective equipment that may be required for certain operations.



Ear Protection



Safety Footwear



Head Protection



Safety Gloves



Dust / Allergens Protection



Eye Protection



Protective Clothing



Caution Floorsign

NOTE:

A risk assessment should be conducted to determine which PPE should be worn.

Information for Wet & Dry Use Vacuum Cleaners

WARNING

Read the instruction manual before using the machine.

Operators shall be adequately instructed on the use of these machines.

As with all electrical equipment, care and attention must be exercised at all times during use, in addition to ensuring that routine and preventative maintenance is carried out periodically to ensure safe operation.

Failure to carry out maintenance as necessary, including the replacement of parts to the correct standard could render this equipment unsafe and the manufacturer can accept no responsibility in this respect.

The machine shall be disconnected from the mains by removing the plug from the supply socket during cleaning or maintenance and when replacing parts or converting the machine to another function.

The machine is not to be used by children or persons with reduced physical, sensory or mental capabilities, or lack of experience or knowledge, unless they have been given supervision or instruction.

Children being supervised are NOT to play with the machine.

This appliance is intended to be assembled, cleaned and maintained by an adult.

This machine is not a toy.

CAUTION!

If foam/liquid comes out of machine exhaust, switch off immediately. Allow the accumulated liquid to drain out through the machine exhaust, check the float assembly to ensure correct operation, empty the container if full of liquid, reassemble the machine. Immediately upon start up there will be a certain amount of liquid issuing from the machine exhaust which will be the residue of liquid still within the power head. This will be quickly discharged after which the machine should function normally.

Liquid ejected from the machine could be hazardous as a result of its temperature, pressure or chemical content.

This machine is not suitable for the collection of biological hazards, hazardous or explosive dust. You should contact your local distributor if you require a machine capable of performing these tasks.

Ensure that the filtration system fitted to the machine is suitable for the material being collected.

This machine is for indoor use only.

This machine shall be stored indoors only

This product complies with the requirements IEC 60335 -2.69.

When moving from one place to another, consider the weight of the machine.

NOTE: This machine is also suitable for commercial use, for example in hotels, schools, hospitals, factories, shops and offices for other than normal housekeeping purposes.

DO

- Use a bag and filter at all times when using 'dry'.
- Keep your machine clean.
- Keep filters clean.
- Regularly clean the water level limiting float safety valve and examine for signs of damage or correct operation.
- Keep hoses and tubes clear.
- Replace any worn or damaged parts immediately.
- Regularly examine the power cord, if damage is found, power cord must be replaced by a qualified person using the correct Numatic original part.
- Empty dust container frequently.
- Keep diffuser filter (where fitted) clean.

DON'T

- Use steam cleaners or pressure washers to clean the machine or use the machine in the rain.
- Immerse in water for cleaning.
- Allow any inexperienced repairs. Call the experts.
- Use wet if float valve is not functioning or fitted.
- Use to suck up hot ashes, or lighted cigarette ends.
- Suck up liquid before emptying dirt from container.
- Suck up dirt before emptying liquid from container.
- Run the machine over the power cable during operation as a hazard may occur.
- Pull on the cable to unplug the machine from the power supply.
- Walk over-wet carpets, upholstery or fabrics.
- Walk on clean carpets until fully dry.
- Spray onto people or animals.
- Attempt machine maintenance or cleaning unless the power supply plug has been removed from the supply outlet.

This machine can be used for wet and dry pick up.

Dry Mode maintenance / fault finding

If the vacuum cleaner stops working switch off and remove the plug from the wall before investigating where the fault lies.

If the vacuum cleaner will not pick up any debris from the surface, switch off and remove the plug from the wall, inspect the floor tool, wands and hose for blockages, if no blockages are found, the dust bag may be full if the dust bag is not full the filter may be blocked.

Wet mode / fault finding

If the vacuum cleaner stops working switch off and remove the plug from the wall before investigating where the fault lies.

If the vacuum cleaner has a blockage and will not pick up liquid, switch off and remove the plug from the wall, has the float valve operated, this will shut off the suction and the pitch of the vacuum motor will change. Remove the power head and empty the liquid out of the container, if the container is empty, check that the floor tool wands and hose are not blocked.

After use always inspect the machine for damage.





EU DECLARATION OF CONFORMITY

We hereby declare that the following equipment fulfils all the relevant provisions of:

Machinery Directive 2006/42/EC
 EMC Directive 2004/108/EC
 Low Voltage Directive 2006/95/EC

Machine Description: Vacuum Cleaner
Type: CVC, WV, WX series
Manufactured by: Numatic International Limited

This equipment has been designed and manufactured in accordance with the following harmonised European standards:

IEC60335-2-69:2002 +A1:2004 +A2:2006
IEC60335-1:2001 +A1:2004 +A2:2006
IEC60335-2-2:2002 +A1:2004 +A2:2006

EN 55014-1:2006
EN 55014-2 1997 +A2 2008
EN 50366 2003

A technical construction file for this equipment is retained at the manufacturer's address.

Signed:  Date: 11/05/2010

Name: Allyn Boyes Position: Technical Manager

GB

Numatic International Limited,
 Chard, Somerset.
 TA20 2GB

www.numatic.co.uk

Numatic International Warranty

Numatic International Limited warrant to the original purchaser that its products are free of defects in both material or workmanship for the period shown below:-

Homecare and Cleancare Vacuum cleaners.....	2 Years
Rotary Floor Machines.....	2 Years
Twintec Auto Scrubber Dryer.....	1 Year
Vario Ride-On Scrubber Dryer.....	1 Year / 1500 hours
Mopping, Compacts, Combi and Servocare Products.....	1 Year
Individual Accessories and Spare Parts.....	6 Months

Note: This warranty expressly excludes consumable parts such as carbon brushes, floor brushes, mops, batteries etc, that are considered replaceable from time to time during the normal working life of the machine.

- A. The warranty period commences from the date the goods are purchased.
- B. All warranty claims must be processed through the Dealer from whom the equipment was purchased. The Dealer will co-operate with the purchaser throughout the warranty claims procedure and will arrange any necessary repairs using genuine Numatic parts.
- C. If the original Dealer is no longer able to fulfil his obligations please contact Numatic International Limited with full details of the claim and proof of purchase so that this may be processed without delay.
- D. Any warranty claim can only relate to the specific part that is proven to be at fault and for which a replacement will be supplied but cannot be extended to constitute a claim against the complete machine.
- E. Numatic International will supply the Dealer with any warranty parts required, subject to the claim being validated, after return of the faulty items in accordance with Numatic International Limited's General Conditions of Sale.
- F. Claims will not be accepted if they are the result of fair wear and tear, misuse or abuse of any kind.
- G. No replacement will be given unless the appropriate evidence of the validity of the claim has been provided to the satisfaction of Numatic International Limited.
- H. Numatic International Limited reserve the right to charge for any unnecessary work carried out as a result of an invalid claim.
- I. No variation to this warranty may be made or implied by any member of Numatic International Limited or its Dealers unless such variation is in writing and authorised by the Company.





Numatic International Limited, Chard, Somerset, TA20 2JH
Telephone: 01432 28030 Fax: 01432 69455
© Numatic International Limited

Data CVC 370 - WV 370 - WV 470

	Motor	AirFlo	Suction	Cleaning Range	Class
CVC 370 WV 370 WV 470	1200W 1200W 1200W	40 L/sec 40 L/sec 40 L/sec	2500 mm 2500 mm 2500 mm	28.8m 28.8m 28.8m	II
	Capacity Dry	Capacity Wet	Size	Weight	Sound Pressure
CVC 370 WV 370 WV 470	15 Ltrs 15 Ltrs 27 Ltrs	9 Ltrs 9 Ltrs 20 Ltrs	355x355x510 355x355x510 355x355x710	7.1 Kgs 7.1 Kgs 9.6 Kgs	73-77 dB (IEC 60704-2-1) Uncertainty: 0.2 dB (A)



	Failure to rectify the problem or in the event of a breakdown contact your Numatic dealer or the Numatic Technical Helpline +44 (0)1461 269268
	Wenn Sie das Problem nicht beheben können oder wenn es zu einer Störung kommt, wenden Sie sich an Ihren Numatic-Händler oder rufen Sie bei der Numatic-Technische Hotline an unter 0049 (0)511 9342160
	Si vous ne parvenez pas résoudre le problème ou en cas de panne, contactez votre revendeur Numatic ou le service d'assistance technique Numatic au +33164726161.
	Neem contact op met uw Numatic-verkoper als u het probleem niet kunt verhelpen of de machine dienst weigert. U kunt ook de technische helplijn van Numatic bellen op +31 172 467 969.
	Failure to rectify the problem or in the event of a breakdown contact your Numatic dealer or the Numatic Technical Helpline 0861 605 284

12" Plastic WV / CVC
WD-0239 (A02)

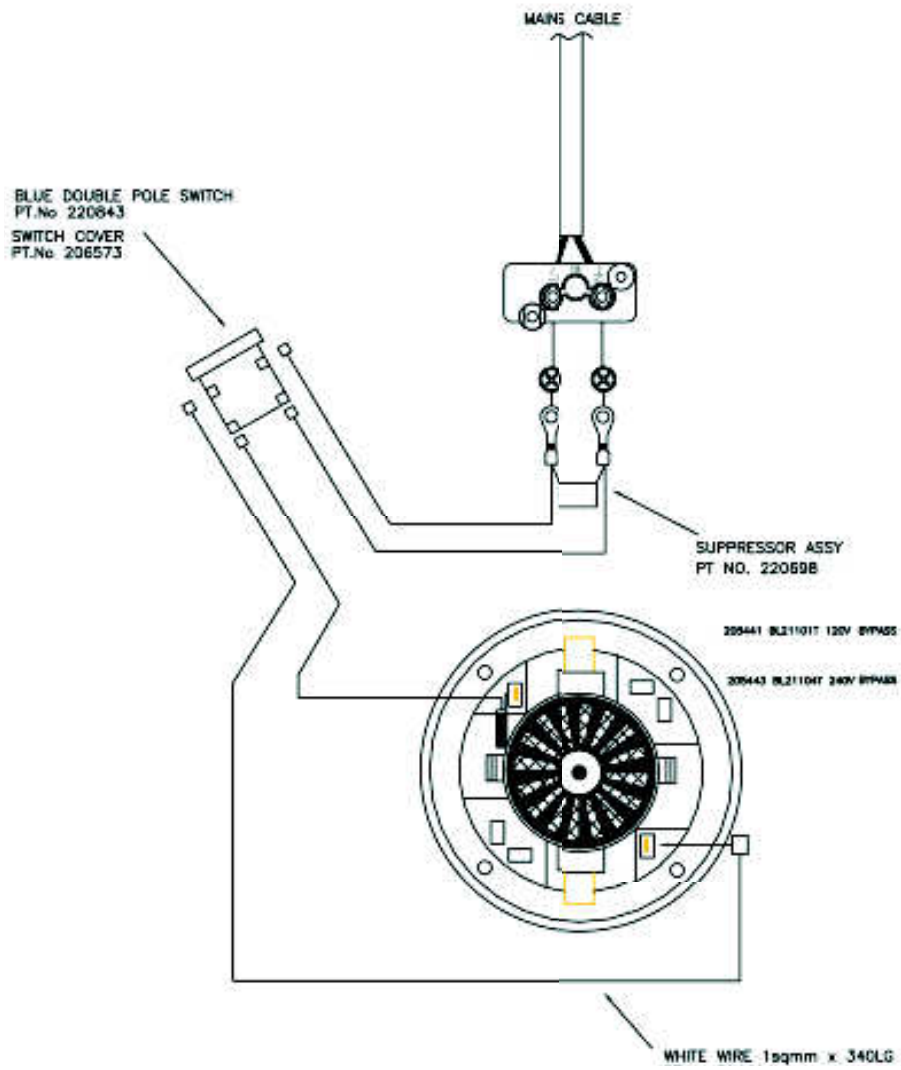



Original Instructions

Warning! Read instructions before using machine



Operating Instructions

CVC 370

WV 370

WVT 370

WV 380

WV 470

Contents / Kits - AA12

2



Kit A21A

CVC 370



Kit AA12

WV 370
WV 380
WV 470



WVT 370

CVC 370 - WV 370
WV 380 - WVT 370



604016
NVM 2BH

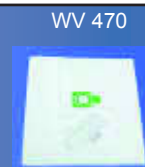

WV 470

604018
NVM 3AH



Wet - Assembling the machine

Wet - Using the machine

4

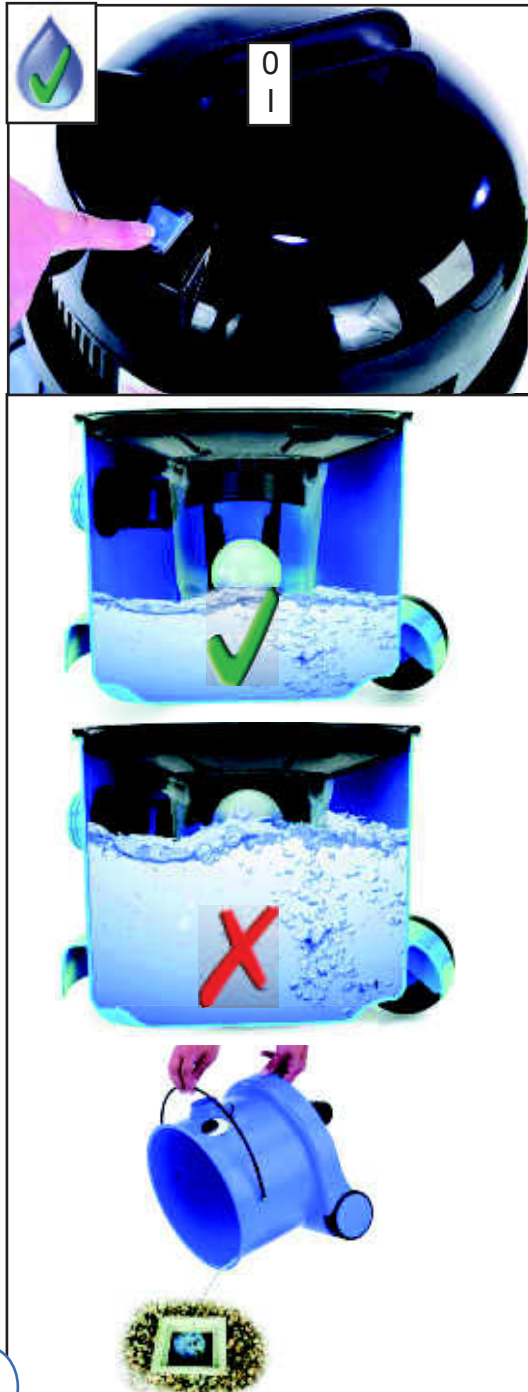



Dry- Assembling the machine

Assembling the Machine

6

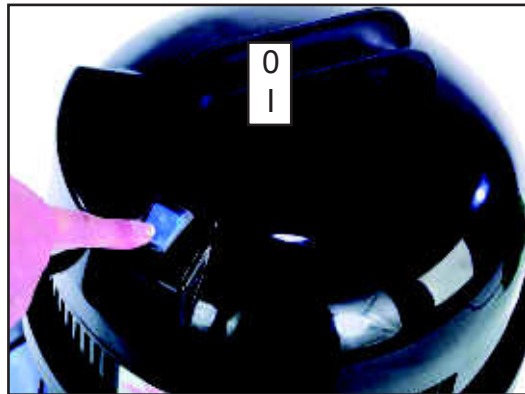
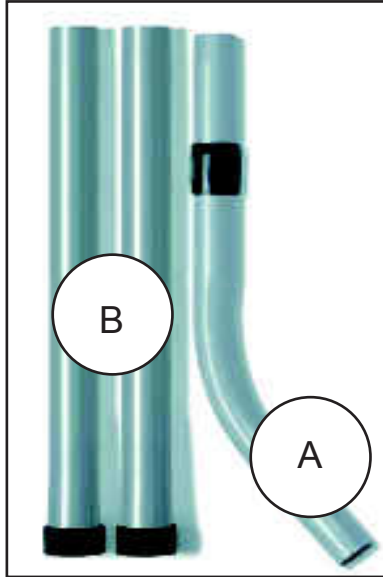
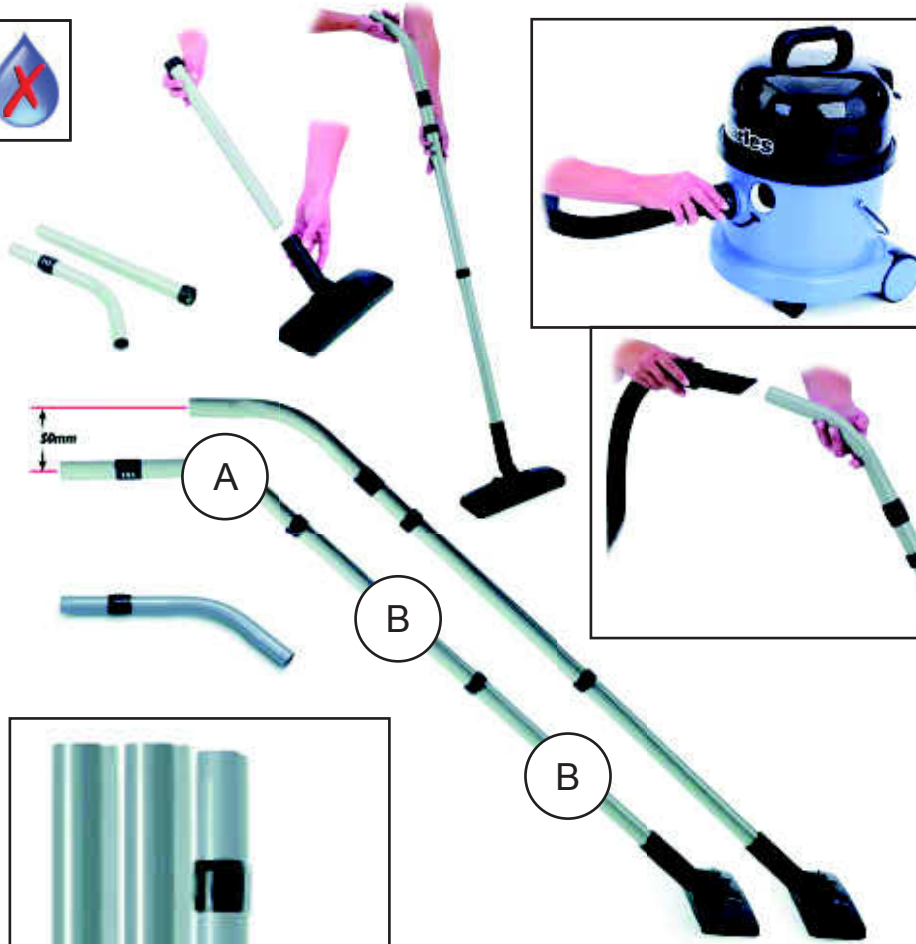

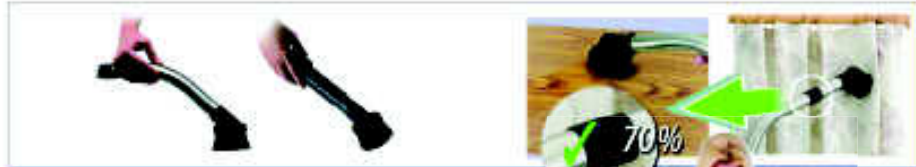
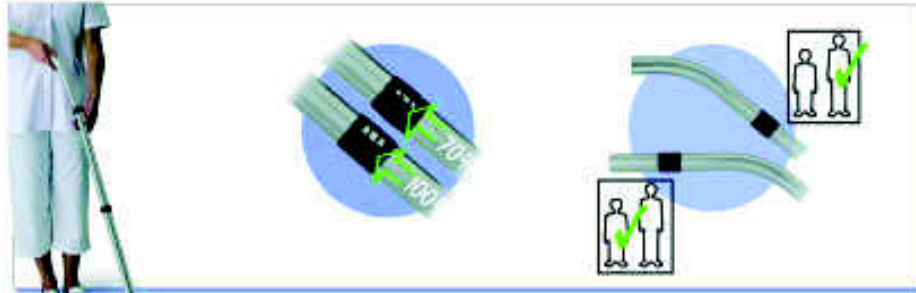

Using the machine

7

470 Handle Locking Instructions

8



About the machine

Company name and address

Weight (Ready to use) — 7.1 Kg

Voltage / Frequency — 230V~, 50-60 Hz

Power Rating — 1200W, 1000W

Splash Proof Rating — IPX4

Machine Description — CVC 370

WEEE Logo

Class 2 Symbol

CE Mark

Yr / Wk / Serial Number

**WEEE Legislation
(Waste, Electrical and Electronic Equipment)**

Vacuum cleaner, accessories and packaging should be sorted for environmental-friendly recycling.

Only for EU countries:
Do not dispose of Vacuum cleaner into household waste!
According to the European Directive 2002/96/EC on waste electrical and electronic equipment and its incorporation into national law.

Vacuum cleaners that are no longer suitable for use must be separately collected and sent for recovery in an environmental-friendly manner.

Safety Critical Components

Mains lead HO5VV-F x 10m x 2 x 1.00mm²

Filter Bag
(370 - 380 drum) NVM-2 BH >pp< construction 99.6%@0.3µm
(470 Drum) NVM-3 AH >pp< construction 99.6%@0.3µm

Filter

Tritex	NVM 604165 >pp< construction	96.0%@0.3µm
Microtex	NVM 604311 >pp< construction	99.6%@0.3µm
Microfresh	NVM 604170 >pp< construction	98.4%@0.3µm

PPE

Personal protective equipment that may be required for certain operations.



Ear Protection



Safety Footwear



Head Protection



Safety Gloves



Dust / Allergens Protection



Eye Protection



Protective Clothing



Caution Floorsign

NOTE:

A risk assessment should be conducted to determine which PPE should be worn.

Rating Label - WEEE - PPE - Safety Critical Components



Information for Wet & Dry Use Vacuum Cleaners

WARNING

Read the instruction manual before using the machine.

Operators shall be adequately instructed on the use of these machines.

As with all electrical equipment, care and attention must be exercised at all times during use, in addition to ensuring that routine and preventative maintenance is carried out periodically to ensure safe operation.

Failure to carry out maintenance as necessary, including the replacement of parts to the correct standard could render this equipment unsafe and the manufacturer can accept no responsibility in this respect.

The machine shall be disconnected from the mains by removing the plug from the supply socket during cleaning or maintenance and when replacing parts or converting the machine to another function.

The machine is not to be used by children or persons with reduced physical, sensory or mental capabilities, or lack of experience or knowledge, unless they have been given supervision or instruction.

Children being supervised are NOT to play with the machine.

This appliance is intended to be assembled, cleaned and maintained by an adult.

This machine is not a toy.

CAUTION!

If foam/liquid comes out of machine exhaust, switch off immediately. Allow the accumulated liquid to drain out through the machine exhaust, check the float assembly to ensure correct operation, empty the container if full of liquid, reassemble the machine. Immediately upon start up there will be a certain amount of liquid issuing from the machine exhaust which will be the residue of liquid still within the power head. This will be quickly discharged after which the machine should function normally.

Liquid ejected from the machine could be hazardous as a result of its temperature, pressure or chemical content.

This machine is not suitable for the collection of biological hazards, hazardous or explosive dust. You should contact your local distributor if you require a machine capable of performing these tasks.

Ensure that the filtration system fitted to the machine is suitable for the material being collected.

This machine is for indoor use only.

This machine shall be stored indoors only

This product complies with the requirements IEC 60335 -2.69.

When moving from one place to another, consider the weight of the machine.

NOTE: This machine is also suitable for commercial use, for example in hotels, schools, hospitals, factories, shops and offices for other than normal housekeeping purposes.

DO

- Use a bag and filter at all times when using 'dry'.
- Keep your machine clean.
- Keep filters clean.
- Regularly clean the water level limiting float safety valve and examine for signs of damage or correct operation.
- Keep hoses and tubes clear.
- Replace any worn or damaged parts immediately.
- Regularly examine the power cord, if damage is found, power cord must be replaced by a qualified person using the correct Numatic original part.
- Empty dust container frequently.
- Keep diffuser filter (where fitted) clean.

DON'T

- Use steam cleaners or pressure washers to clean the machine or use the machine in the rain.
- Immerse in water for cleaning.
- Allow any inexperienced repairs. Call the experts.
- Use wet if float valve is not functioning or fitted.
- Use to suck up hot ashes, or lighted cigarette ends.
- Suck up liquid before emptying dirt from container.
- Suck up dirt before emptying liquid from container.
- Run the machine over the power cable during operation as a hazard may occur.
- Pull on the cable to unplug the machine from the power supply.
- Walk over-wet carpets, upholstery or fabrics.
- Walk on clean carpets until fully dry.
- Spray onto people or animals.
- Attempt machine maintenance or cleaning unless the power supply plug has been removed from the supply outlet.

This machine can be used for wet and dry pick up.

Dry Mode maintenance / fault finding

If the vacuum cleaner stops working switch off and remove the plug from the wall before investigating where the fault lies.

If the vacuum cleaner will not pick up any debris from the surface, switch off and remove the plug from the wall, inspect the floor tool, wands and hose for blockages, if no blockages are found, the dust bag may be full if the dust bag is not full the filter may be blocked.

Wet mode / fault finding

If the vacuum cleaner stops working switch off and remove the plug from the wall before investigating where the fault lies.

If the vacuum cleaner has a blockage and will not pick up liquid, switch off and remove the plug from the wall, has the float valve operated, this will shut off the suction and the pitch of the vacuum motor will change. Remove the power head and empty the liquid out of the container, if the container is empty, check that the floor tool wands and hose are not blocked.

After use always inspect the machine for damage.





EU DECLARATION OF CONFORMITY

We hereby declare that the following equipment fulfils all the relevant provisions of:

Machinery Directive 2006/42/EC
 EMC Directive 2004/108/EC
 Low Voltage Directive 2006/95/EC

Machine Description: Vacuum Cleaner
Type: CVC, WV, WX series
Manufactured by: Numatic International Limited

This equipment has been designed and manufactured in accordance with the following harmonised European standards:

IEC60335-2-69:2002 +A1:2004 +A2:2006
IEC60335-1:2001 +A1:2004 +A2:2006
IEC60335-2-2:2002 +A1:2004 +A2:2006

EN 55014-1:2006
EN 55014-2 1997 +A2 2008
EN 50366 2003

A technical construction file for this equipment is retained at the manufacturer's address.

Signed:  Date: 11/05/2010

Name: Allyn Boyes Position: Technical Manager

GB

Numatic International Limited,
 Chard, Somerset.
 TA20 2GB

www.numatic.co.uk

Numatic International Warranty

Numatic International Limited warrant to the original purchaser that its products are free of defects in both material or workmanship for the period shown below:-

Homecare and Cleancare Vacuum cleaners.....	2 Years
Rotary Floor Machines.....	2 Years
Twintec Auto Scrubber Dryer.....	1 Year
Vario Ride-On Scrubber Dryer.....	1 Year / 1500 hours
Mopping, Compacts, Combi and Servocare Products.....	1 Year
Individual Accessories and Spare Parts.....	6 Months

Note: This warranty expressly excludes consumable parts such as carbon brushes, floor brushes, mops, batteries etc, that are considered replaceable from time to time during the normal working life of the machine.

- A. The warranty period commences from the date the goods are purchased.
- B. All warranty claims must be processed through the Dealer from whom the equipment was purchased. The Dealer will co-operate with the purchaser throughout the warranty claims procedure and will arrange any necessary repairs using genuine Numatic parts.
- C. If the original Dealer is no longer able to fulfil his obligations please contact Numatic International Limited with full details of the claim and proof of purchase so that this may be processed without delay.
- D. Any warranty claim can only relate to the specific part that is proven to be at fault and for which a replacement will be supplied but cannot be extended to constitute a claim against the complete machine.
- E. Numatic International will supply the Dealer with any warranty parts required, subject to the claim being validated, after return of the faulty items in accordance with Numatic International Limited's General Conditions of Sale.
- F. Claims will not be accepted if they are the result of fair wear and tear, misuse or abuse of any kind.
- G. No replacement will be given unless the appropriate evidence of the validity of the claim has been provided to the satisfaction of Numatic International Limited.
- H. Numatic International Limited reserve the right to charge for any unnecessary work carried out as a result of an invalid claim.
- I. No variation to this warranty may be made or implied by any member of Numatic International Limited or its Dealers unless such variation is in writing and authorised by the Company.







Numatic International Limited, Chard, Somerset, TA20 2JH
Telephone: 01432 28030 Fax: 01432 69455
© Numatic International Limited

Data CVC 370 - WV 370 - WV 470

	Motor	AirFlo	Suction	Cleaning Range	Class
CVC 370 WV 370 WV 470	1200W 1200W 1200W	40 L/sec 40 L/sec 40 L/sec	2500 mm 2500 mm 2500 mm	28.8m 28.8m 28.8m	II
	Capacity Dry	Capacity Wet	Size	Weight	Sound Pressure
CVC 370 WV 370 WV 470	15 Ltrs 15 Ltrs 27 Ltrs	9 Ltrs 9 Ltrs 20 Ltrs	355x355x510 355x355x510 355x355x710	7.1 Kgs 7.1 Kgs 9.6 Kgs	73-77 dB (IEC 60704-2-1) Uncertainty: 0.2 dB (A)



	Failure to rectify the problem or in the event of a breakdown contact your Numatic dealer or the Numatic Technical Helpline +44 (0)1461 269268
	Wenn Sie das Problem nicht beheben können oder wenn es zu einer Störung kommt, wenden Sie sich an Ihren Numatic-Händler oder rufen Sie bei der Numatic-Technische Hotline an unter 0049 (0)511 9342160
	Si vous ne parvenez pas résoudre le problème ou en cas de panne, contactez votre revendeur Numatic ou le service d'assistance technique Numatic au +33164726161.
	Neem contact op met uw Numatic-verkoper als u het probleem niet kunt verhelpen of de machine dienst weigert. U kunt ook de technische helplijn van Numatic bellen op +31 172 467 969.
	Failure to rectify the problem or in the event of a breakdown contact your Numatic dealer or the Numatic Technical Helpline 0861 605 284

12" Plastic WV / CVC
WD-0239 (A02)

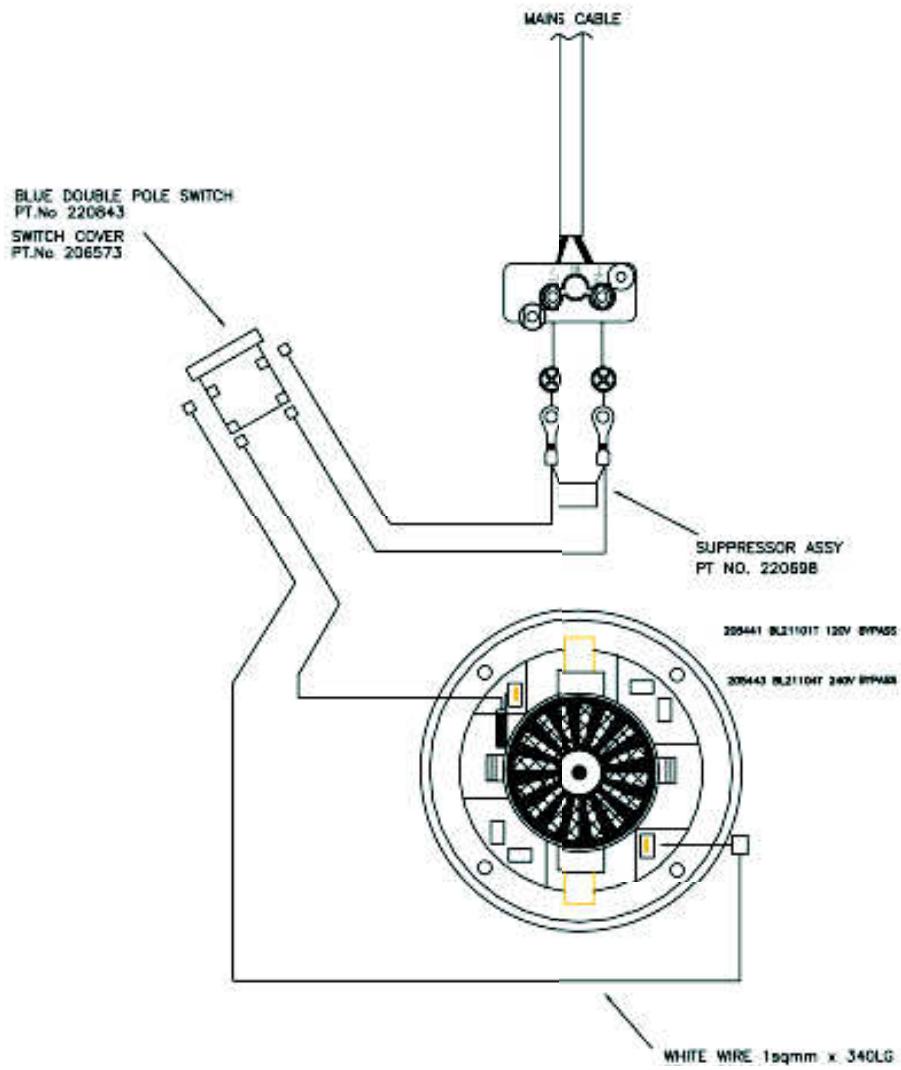

Machine Spare Parts

 588256 CVC 370 Head	 588255 WV 370 Head	 588261 WV 470 Head
 500816 370 Blue Drum	 500081 Blue 380 Drum	 500362 470 Blue Drum
 204111 370 Castor	 380 Castor 628485	 204071 470 Rear Wheel
 204111 470 Castor	 370 Rear Wheel 227640 Rear Wheel 227868 Wheel Hub 219105 Fixing Screw 229777 Blue Trim	 500694 370 Blue Drum
 604165 Tritex Filter		 502036 CVC / WV Float Cage



Re - Order
370 /380 Drum
 Hepaflo Bags
 Pack of 10
 NVM-2BH
 604016



Re - Order
470 Drum
 Hepaflo Bags
 Pack of 10
 NVM-3AH
 604018

